

OPERATING MANUAL

ENGLISH



**Thank you for
purchasing our
Room Air Conditioner.**

Before using your air-conditioner, please read this operating instruction carefully and keep it for future reference.

● Function

Introduction

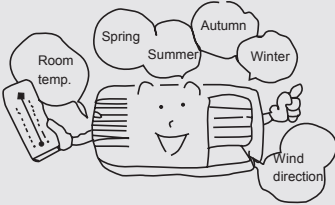

Window type room air conditioners can regulate the room temperature and dry the room. It is convenient for your work, study and life. It can be widely used in residence, shop, hotel, office, library and laboratory, and so on.

Cooling in summer

In hot summer, Air conditioner can cool down the room air by transferring heat out.

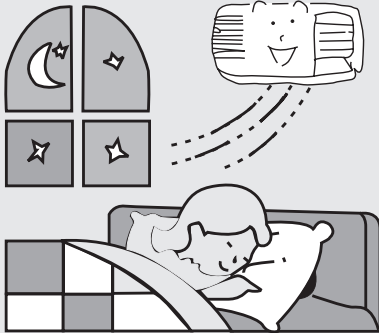

Dehumidifying in rainy or humid season

Without reducing the room temp., air conditioner can dehumidify and make the room air dry and comfortable.

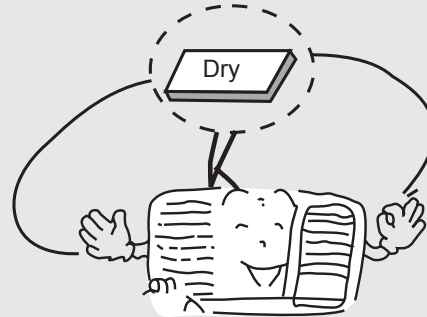

Heating in winter

In cold winter, air conditioner can discharge the cold air from the room and the room will be heated. only when your units have the HEATING function.

Exchange fresh air

Open storm door to keep the fresh air in the room.

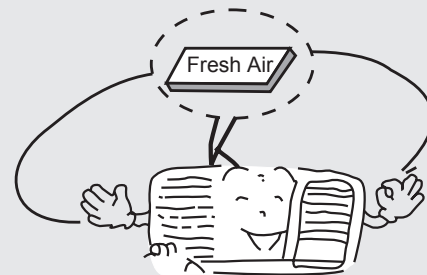

● Remote control panel

Note:

If wireless remote controller is lost, open the control panel and operate manually.

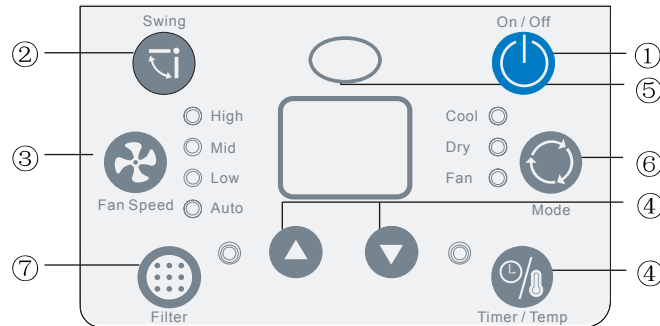

- | | |
|--|---|
| <p>1 ON/OFF OPERATION BUTTON
This button turns the air conditioner ON and OFF.</p> <p>2 SWING BUTTON
Press this button to activate the supply air flap to various position or auto swing.</p> <p>3 FAN SPEED BUTTON
Press the button to select the Low, Middle and Hight Fan Speed.</p> <p>4 TEMP/TIMER BUTTON
Press the ▲ keypad to increase the set (operating) temperature of the unit and Press the ▼ keypad to decrease the set(operating) temperature of the unit. The temperature seting range is from 16~30 °C. Press the ▲ keypad also to increase the selected time in 1 hour increments, and Press the ▼ keypad to decrease the selected time in 1 hour decrements, the time seting range is from 0~24 hours.</p> | <p>5 SIGNAL RECEIVER</p> <p>6 MODE BUTTON
Select the operation mode, AUTO, HEAT, COOL, FAN, DRY (for reverse cycle model) or AUTO,COOL,FAN, DRY (for cooling only model).</p> <p>7 FILTER BUTTON
This feature is a reminder to clean the Air Filter (See Care and Cleaning) for more efficient operation and cooling. The LED (light) will illuminate after 250 hours of operation. To reset after cleaning the filter, press the "Check Filter" button and the light will go off.</p> |
|--|---|

VENTILATION LEVER



Ventilation Lever

When the slider at the:



-"OPEN" position,the ventilation door opens to allow air,smoke or odors to be expelled from the room.

When the slider at the:



-"CLOSE" position,the ventilation door is closed and the air will be circulated inside the room and conditioned.

● Operating Condition

- Please operate air conditioner in the correct conditions as following.

COOL mode operation

Outdoor temperature should be in range of 18 °C to 43 °C, otherwise it is possible for air conditioner to breakdown.

Room humidity should be lower than 90% .
Otherwise, it is possible for air conditioner to dew at air conditioner surface and even drop water after running for so much time. But this maybe normal.

Power requirement



- * The electric components will be damaged when the voltage is too high. If the voltage is too low, the compressor will vibrate violently to damage the refrigerant system and easily cause the compressor and electric components not work.

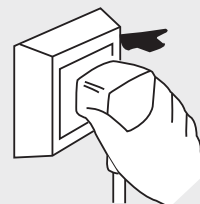

- The ground must be connected.
- * Special socket must be used. Furthermore, the socket and wiring must conform to the wiring regulations. And the earthing method must be reliable.
- * In fixed circuit, there must be electricity leakage protection switch of enough power capacity and air switch with enough space.



Earth wire To ensure the reliable earthing, please do not connect earth wire to the following places:

Water pipe

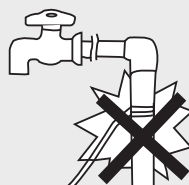

● Installation

Installation precaution:

Window type conditioner is so valuable and the improper installation of it will cause a lot of damage! Please associate the professional technician to install the unit and don't install it by yourself. Otherwise, we are not responsible for the damage like this.



Location:

- The condensation water must be drained away conveniently.
- Install air conditioner unit far away from TV set or radio etc. to avoid disturbing video or voice.
- In salt and coastal area or place where is near thermal springs and polluted by sulphurous gas, or other special areas, please contact the seller before use.
- Avoid a place where is possible for inflammable gas to leak out.
- The minimum clearance from the appliance to combustible surface is 50 mm.
- Avoid other heat sources or direct sun light.
- Avoid a place where is easy for children to touch.
- For window type air conditioner with remote control, install in a location where is strong electromagnetic disturbance, you should contact the seller in advance to avoid the malfunction in use.

How to install:

- Choose a location where there are no any obstacle surrounding the unit.
- Prepare the installation hole slightly bigger than unit size.
- Choose the installation space according to the following diagram.

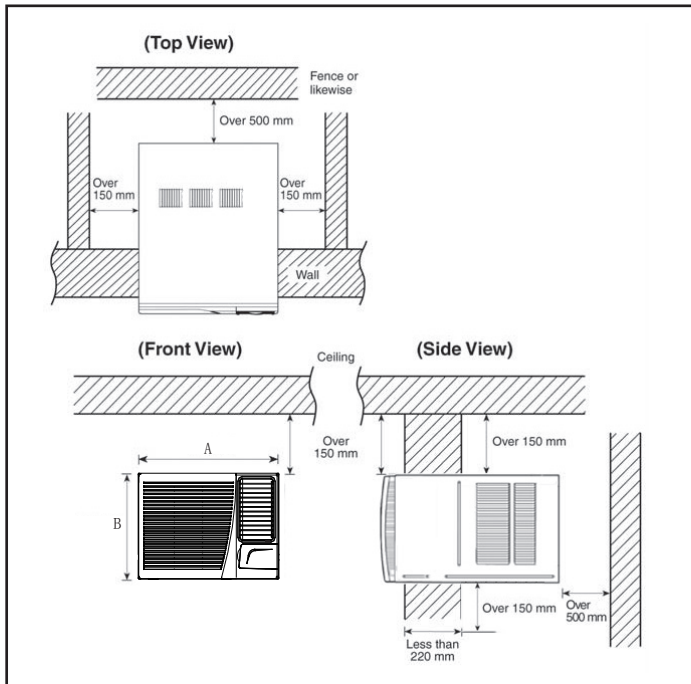

Cooling capability	A	B
7K and 9K	450	350
12K	559	374
18K and 24K	659	427

The distance of obstructions from window unit inside should be upper 300mm, lower 1500mm, left 500mm, right 500mm, front 1500mm.

Installation procedure:

- 1) Remove the sticker from the front panel.
- 2) Put the unit into the installation hole.
 - When installing the unit, it should be slanted down to the back to avoid the enlargement of noise or vibration. (Slant between 6-10mm.) (Shown at right figure.)
 - The installation place should be strong enough to avoid the enlargement of noise or vibration.
- 3) Fill up sews in the cabinet with sponge or foam.

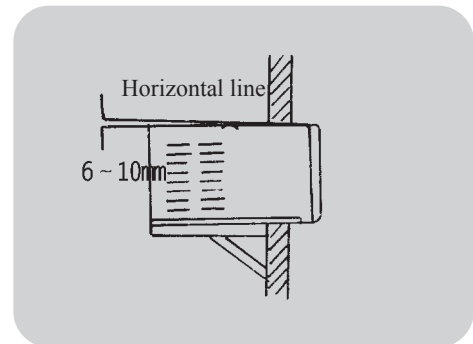

Installation assistance:

- Use iron support
The installation hole should be strong enough to support the air conditioner. If it cannot, iron support has to be used outdoors.
Iron support should be fixed on the building (Shown at right figure.)
- Use sunshade board
Air conditioner should avoid anything to be dropped into it and avoid direct sunshine. If there is no cover on it, you should contact the seller for installing the sunshade board. When installing the sunshade board, don't let it block the air inlet at the side grille.

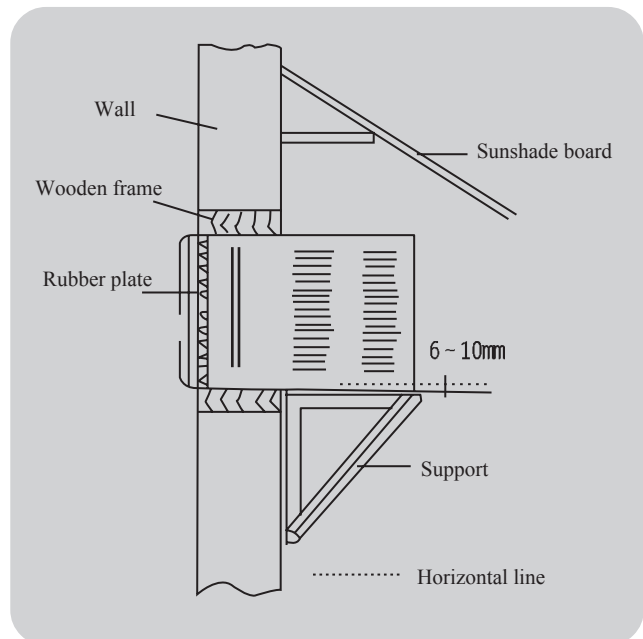

Drain water:

To get the maximum cooling efficiency, the air conditioner is designed to splash the condensation water on the condenser coil.

If the splashing sound annoys you, you can provide an outside drain by using the following procedure, which may however cause a small loss of performance.

1. Slide out the chassis from the cabinet.
2. Remove the rubber plug from the body base plate.
3. Install the drain pan to the corner of the cabinet with 2 screws.
4. Connect the drain hose to the outlet on the drain pan bottom.
5. Slide the chassis into its original place in the cabinet.

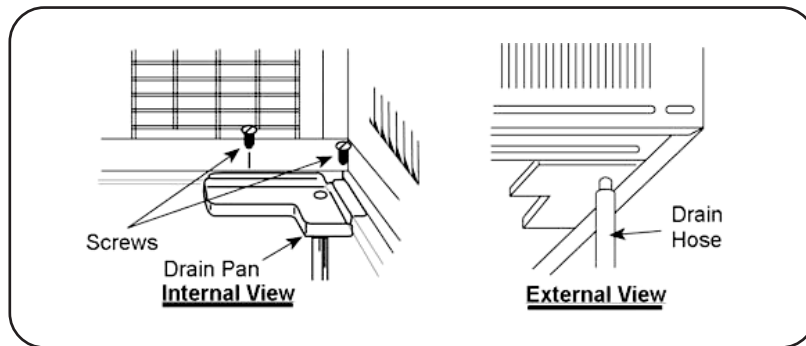

Note:

- Drain hose or tubing can be purchased locally to satisfy your particular needs.

● Notes for installation

Remove

Before removing air conditioner to the other place, you should contact the seller firstly. Then it must be done under the direction of the professional technician. In addition, the charge of this must be paid.

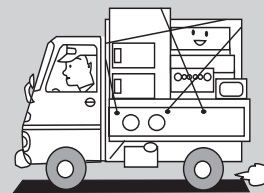

Noise

- Install in a location where is firm enough to avoid the enlargement of noise and vibration.
- Don't put anything in front of the outlet of outdoor unit to avoid increasing noise.
- Be sure that hot air or noise will not inconvenience neighbors.
- Please contact the seller as soon as there is strange noise during operation.
- Please use the safety support.

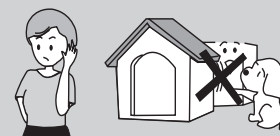

Electric wiring

- Must connect with ground reliably.
- The exclusive circuit must be used. But removable socket can't be used because poor contact of it can cause over heat or fire.
- Don't pull the power cord strongly.
- In fixed circuit, there must be electricity leakage protection switch and leakage current is less than 30mA.
- Air switch (thermal-magnetic breaker) should be installed in the circuit and its capacity is 10A for 7K and 9K, 16A for 12K, 20A for 18K, 25A for 24K.
- The cross section area for fixed wiring should be more than 2.5mm².
- If the supply cord is damaged, It must be replaced by the manufacturer or its service agent or similarly qualified person in order to avoid a hazard.
- The appliance must be positioned so that the plug is accessible.
- The appliance should be installed in accordance with national wiring regulations.



● PART IDENTIFICATION

Panel outlook picture, just for reference, please take the real unit as standard.

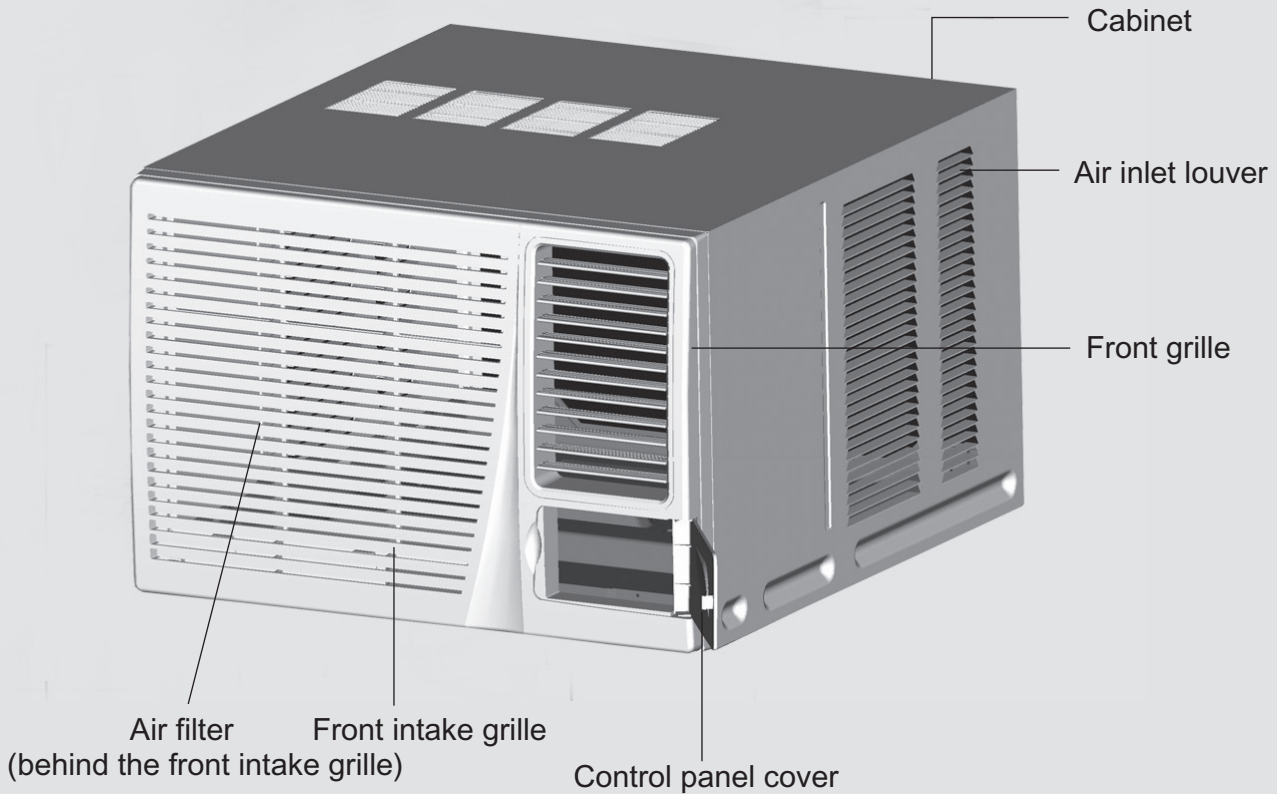

Air direction adjustment

Vertical airflow direction vane

(Airflow direction adjustment up and down).

The vertical airflow direction vane is controlled by positioning the vane to discharge the air upwards, downwards or straight out.

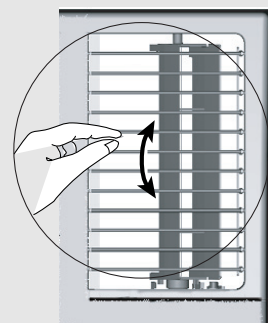

● Operation Tips

Operation for comfort and economy

Do not overcool the room temperature. This is not good for health and wastes electricity.

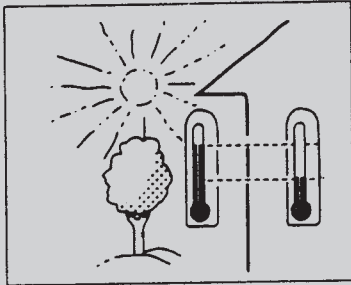

Keep blind or curtains closed. Do not let sunshine enter the room directly when the air conditioning is in operation.

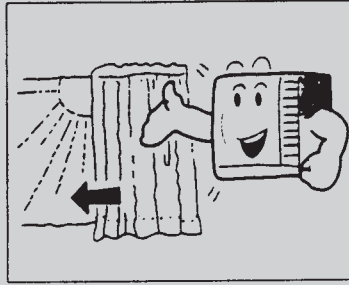

Keep the room temp. uniform. Adjust the vertical and horizontal airflow direction to ensure a uniform temperature in the room. Air can't be discharged to the direction of air-in.

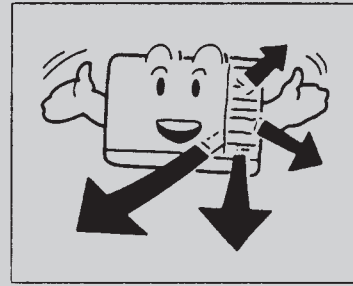

Make sure that the doors and windows are tightly closed. Avoid opening doors and windows as much as possible to keep air conditioning in the room.

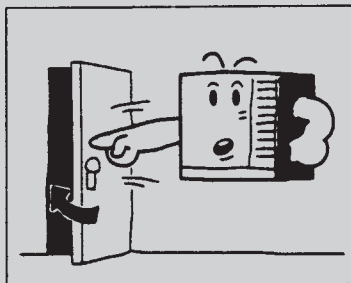

Clean the air filter regularly. Blockages in the air filter reduce dehumidifying effects. Clean the air filter at least once every two weeks.

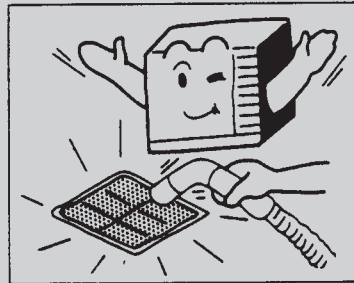

Ventilate the room occasionally. Since windows are kept closed, it is a good idea to open them and ventilate the room now and then. When starting the unit, curtains or windows should be closed to prevent the heat/cool leakage.

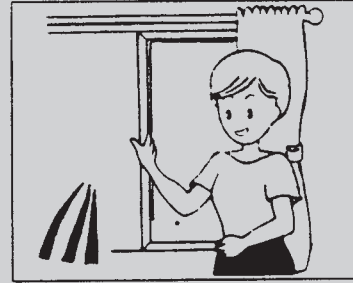

● Caution

- Do not pull out the power cord. Damage to the cord may result in serious electric shocks.
- Do not use the air conditioner for other purposes except for cooling the room.
- Do not use the air conditioner for other purposes such as drying clothes, preserving foods, or cultivating vegetables.
- Do not block the air intake and outlet vents. This causes lowered performance and irregular operation.
- Do not insert sticks or other objects into these vents as it is dangerous to touch the electric components and the fan.

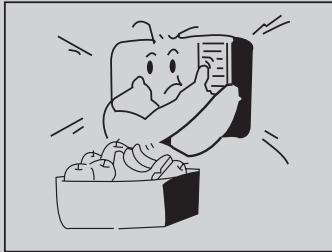
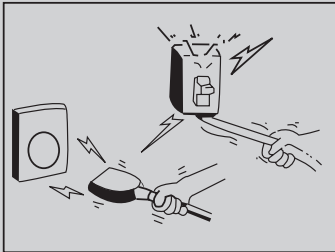

Select the most appropriate temperature. Pay attention to adjust the temperature to suit the conditions. Rooms occupied by infants, the elderly, or the sick should be kept at an appropriate temperature.

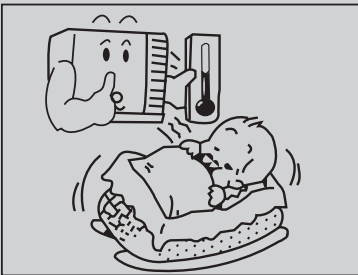

Do not use heating apparatuses in the vicinity. The air conditioner's plastic parts will melt if exposed to excessive heat.

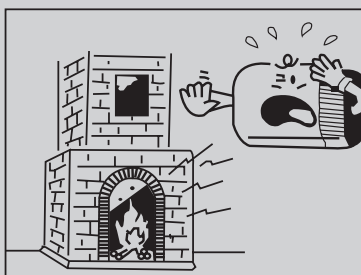

Avoid exposing the body directly to a continuous unidirectional air flow for long periods. This is not recommended for health reason.

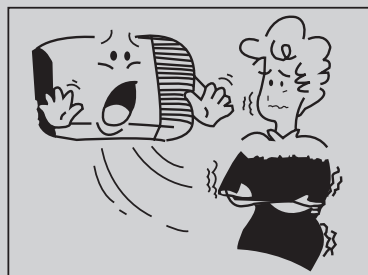

Always wait at least 3 minutes before switching the air conditioner on again after you have switched it off during cooling. The appliance should not be used by children without supervision.

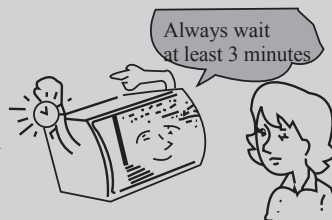

● Care and maintenance

Always turn off the air conditioner and main power supply before cleaning to ensure safety.

Cleaning unit

1. Cut power off before cleaning.

Plug out only after air conditioner stops at all.

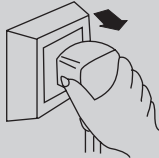

2. Use soft dry cloth when cleaning cabinet.

If the cabinet is very dirty, dip cloth into warm water below 40°C, dry the cloth and then rub off the dirt.



Dry the cloth by hands before cleaning.

3. Don't use gas, benzene, solvent, wash, chemical solvent, etc. for cleaning.



4. Do not splash water directly into indoor unit, in which there are micro-computer and circuit plate, they must not be drenched with water.



* Check earth wire

Is it broken or loose?

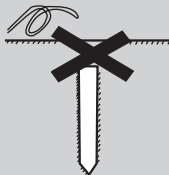

Air filter

The air filter behind the intake grille should be washed at least once every two weeks or as often as it needs cleaning.

How to clean the air filter:

1. To remove the air intake grille, grasp the tab on the filter and pull to take out.

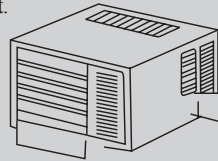

2. Vacuum the filter on the dusty side to remove light dust.



Vacuum cleaner

3. Wash the filter, cleaner side up under gently flowing water to wash out accumulated dust and lint.



4. If the filter is very dirty, use a mild household detergent in the wash water.



Let the filter dry thoroughly before reinstalling it. If necessary, please ask the professional personnel to clean it.





* Check if air inlet and outlet of outdoor unit are blocked or not.

Air lock could result in bad efficiency.



● Trouble shooting guide

Please check the following items before asking for repair, it saves your time and money.

Fault phenomenon	Trouble-shooting
<p>Air conditioner does not operate at all.</p> 	<ul style="list-style-type: none"> * Is there a power failure? * Is the plug out? * Is power fuse or switch off ?
<p>Cool efficiency is not good.</p> 	<ul style="list-style-type: none"> * Is air inlet or outlet locking? * Is there any other heat source in room? * Are air filters dirty very much? * Is indoor fan speed set at LOW? * Maybe the room is too hot when the unit is started, please cool down the room after a period of time.
<p>Foggy air flows out.</p> 	<ul style="list-style-type: none"> * At COOL mode operation, sometimes there is foggy air flowing out of indoor unit, this is because the room humid air has been cooling rapidly. * The unit is normal while the indoor outlet is sending out some odor, because the inlet air may be mixed with the smell of furniture and smoke.
<p>The air conditioner operation is noisy.</p> 	<ul style="list-style-type: none"> * For a noise that sounds like water flowing: This is the sound of freon flowing inside the air conditioner unit. * For a noise that sounds like a shower: This is the sound of the dehumidifying water being processed inside the air conditioner unit.
<p>It seems that condensation is leaking from air conditioner.</p>	<ul style="list-style-type: none"> * Condensation occurs when the airflow from the air conditioner cools the warm room air.
<p>Air conditioner does not operate for about 3 minutes when restart.</p>	<ul style="list-style-type: none"> * This is to protect the mechanism. * Wait about three minutes and operation will begin.

Immediately stop all operations and plug out, please contact your dealer in the following situations.

- *Operation starts or stops abnormally;
- *Power fuse or switch often breaks;
- *Carelessly splash water or something into air conditioner;
- *Electrical lines are much hot or lines cover breaks;
- *Other strange situations.



● Others

- The connection between AC and power cord or among other elements independently shall be subject to wiring diagram on the unit.
- Model and rated value of fuse shall be subject to screen print on corresponding controller or protective bushing.
- The external static pressure at testing place of AC is 0MPa.